



All rights reserved. ©2009 LaserPerformance.
LaserPerformance and associated logos are
trademarks. Laser, SB3, Sunfish, and Dart are
trademarks used under license. LaserPerformance
reserves the right to make design and/or specifica-
tion changes to any of their products as part of
their continuous development program.

Three overlapping, rounded gray shapes are positioned behind the main title. One is a large trapezoid-like shape at the top right, another is a smaller trapezoid-like shape at the bottom left, and the third is a triangular shape at the bottom right. They are all semi-transparent and overlap each other.

Laser Parts Locator

LaserPerformance™



Laser, Radial & 4.7 Spars and Sails

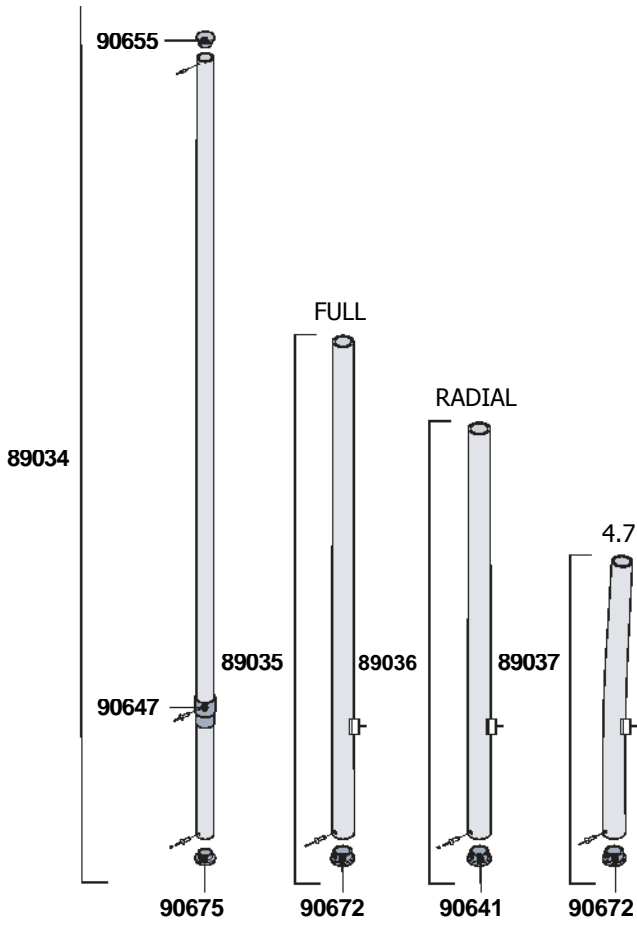

94103 - Rolled Full North
94100 - Folded Full North
94107 - Folded Full Hyde

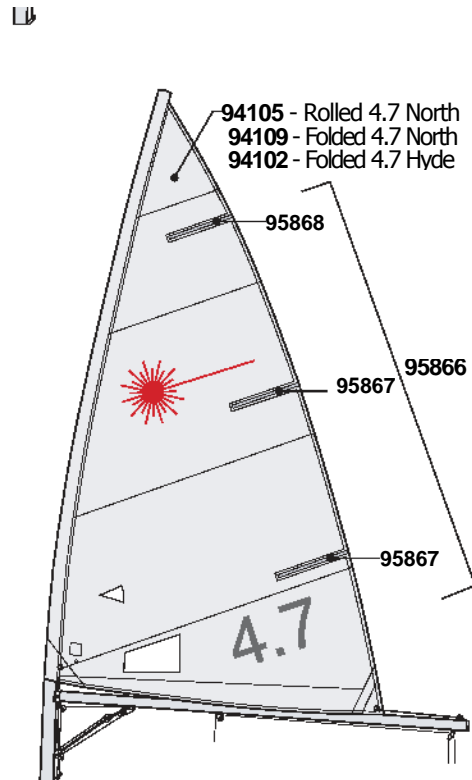
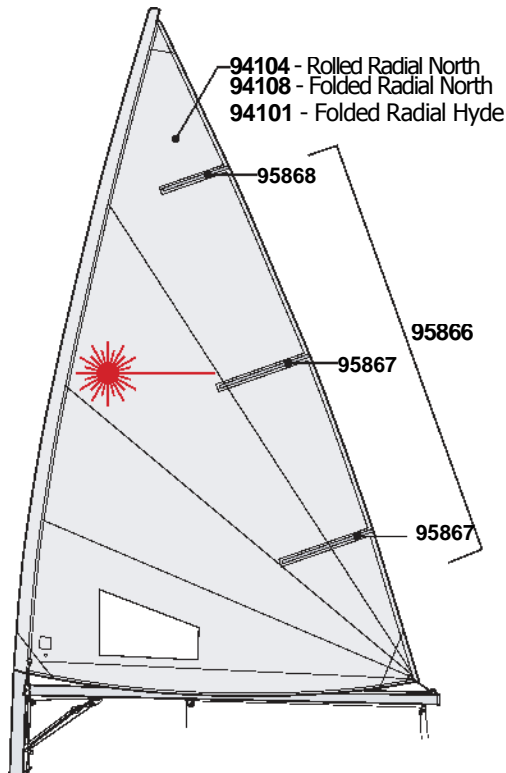
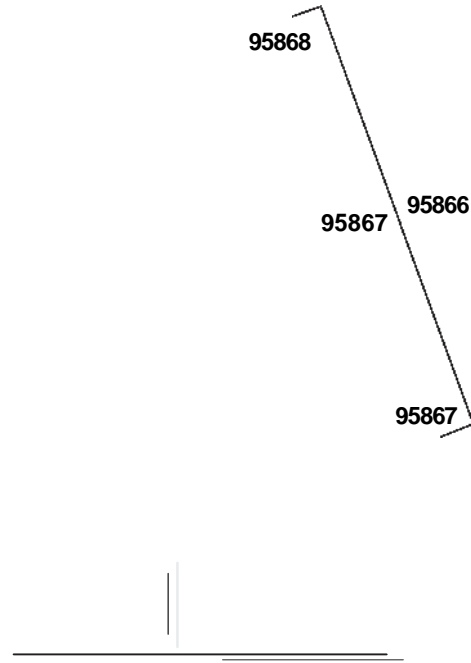

Laser Race Outhaul and Boom Blocks

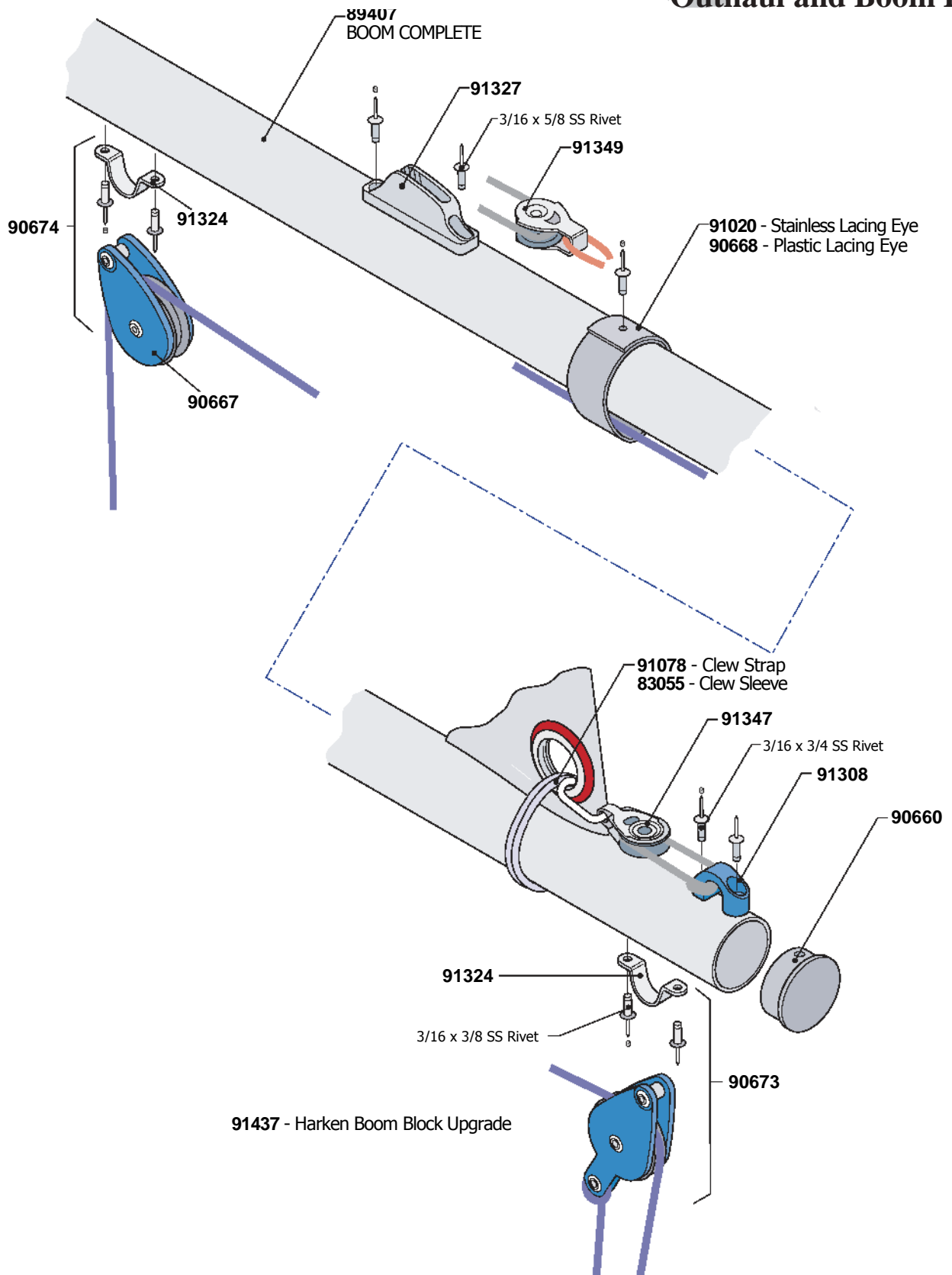



Laser XD Outhaul & Boom Blocks

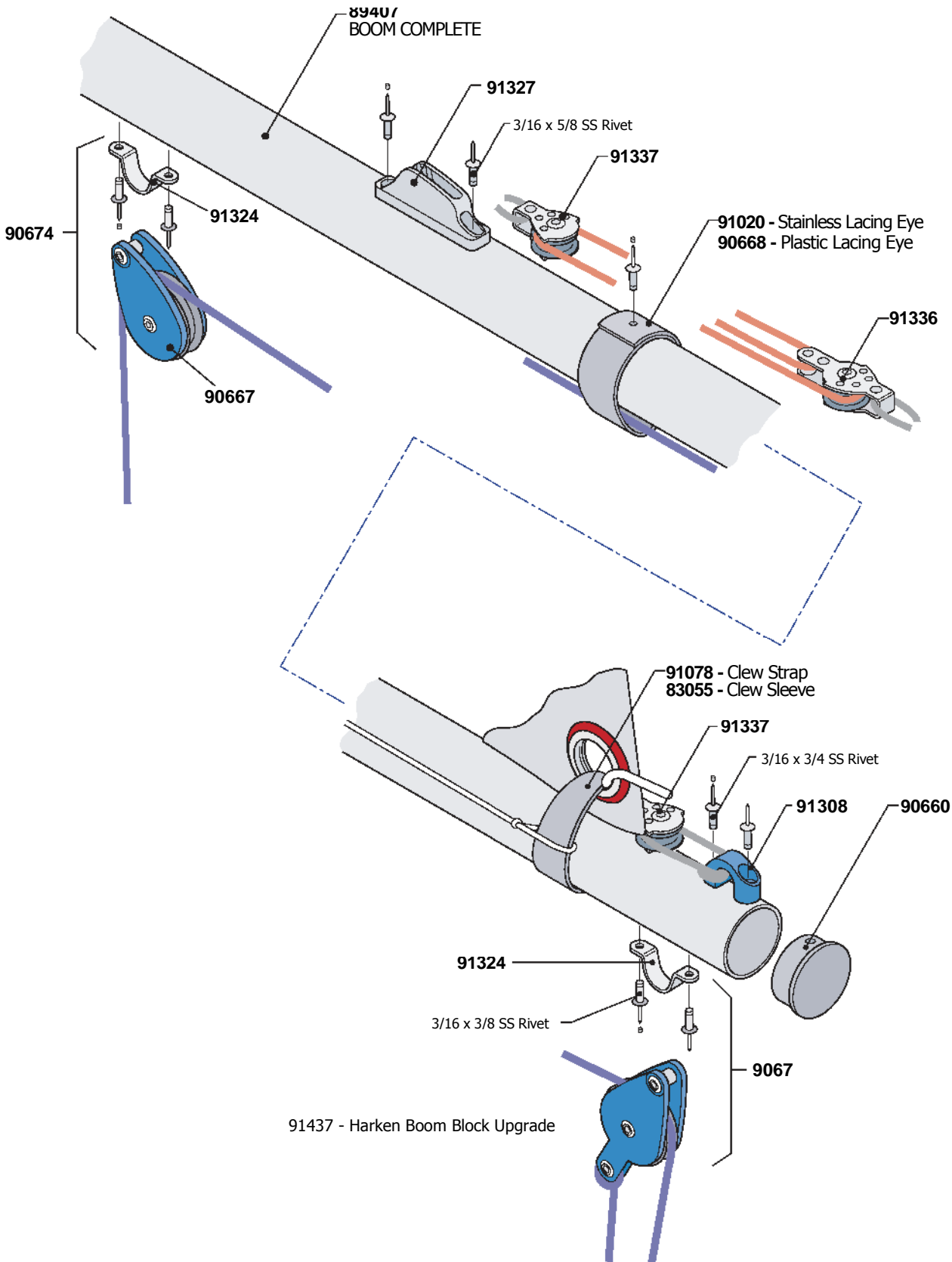

Laser, Race, XD Spar and Gooseneck

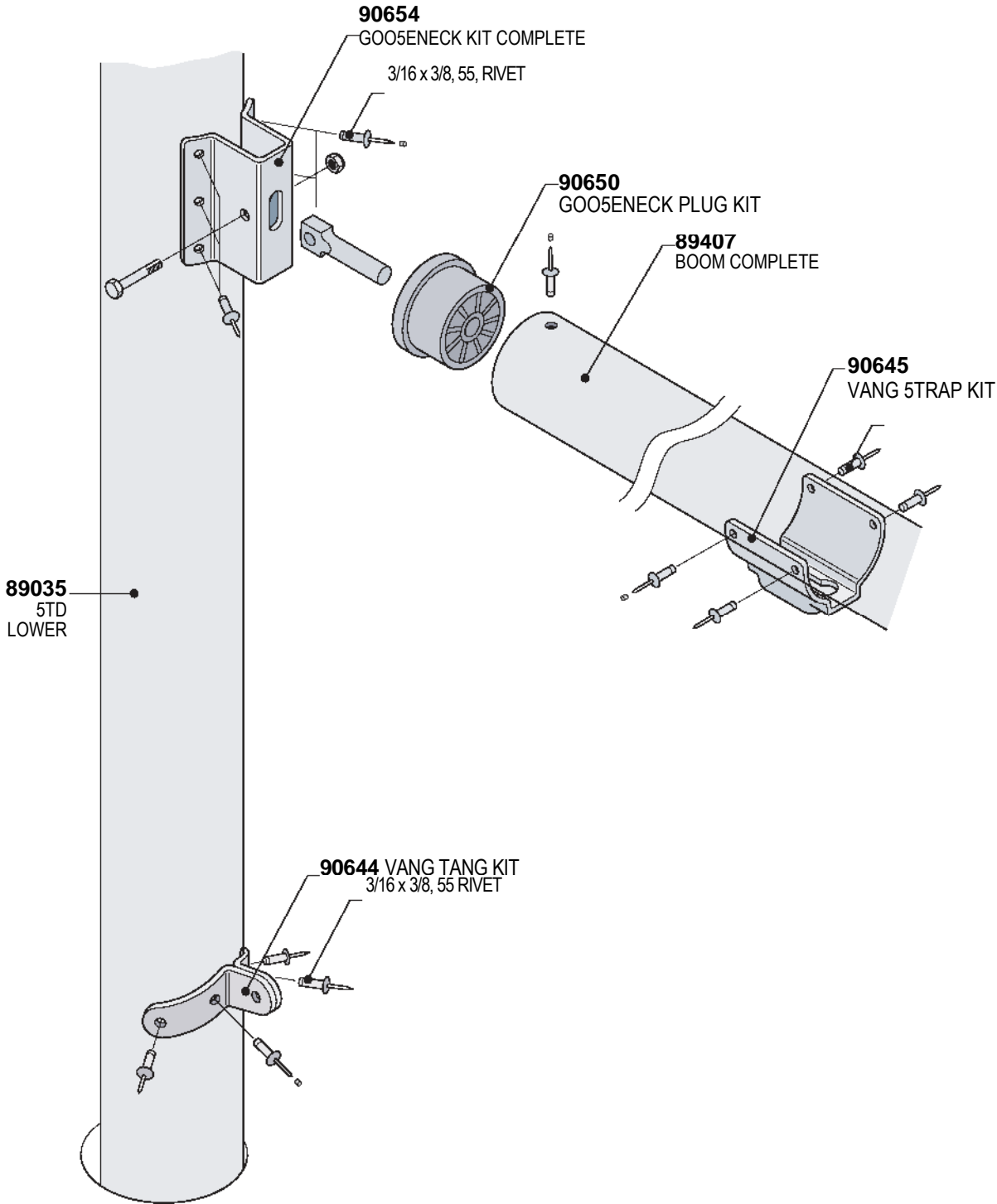



Laser Boom Vang System

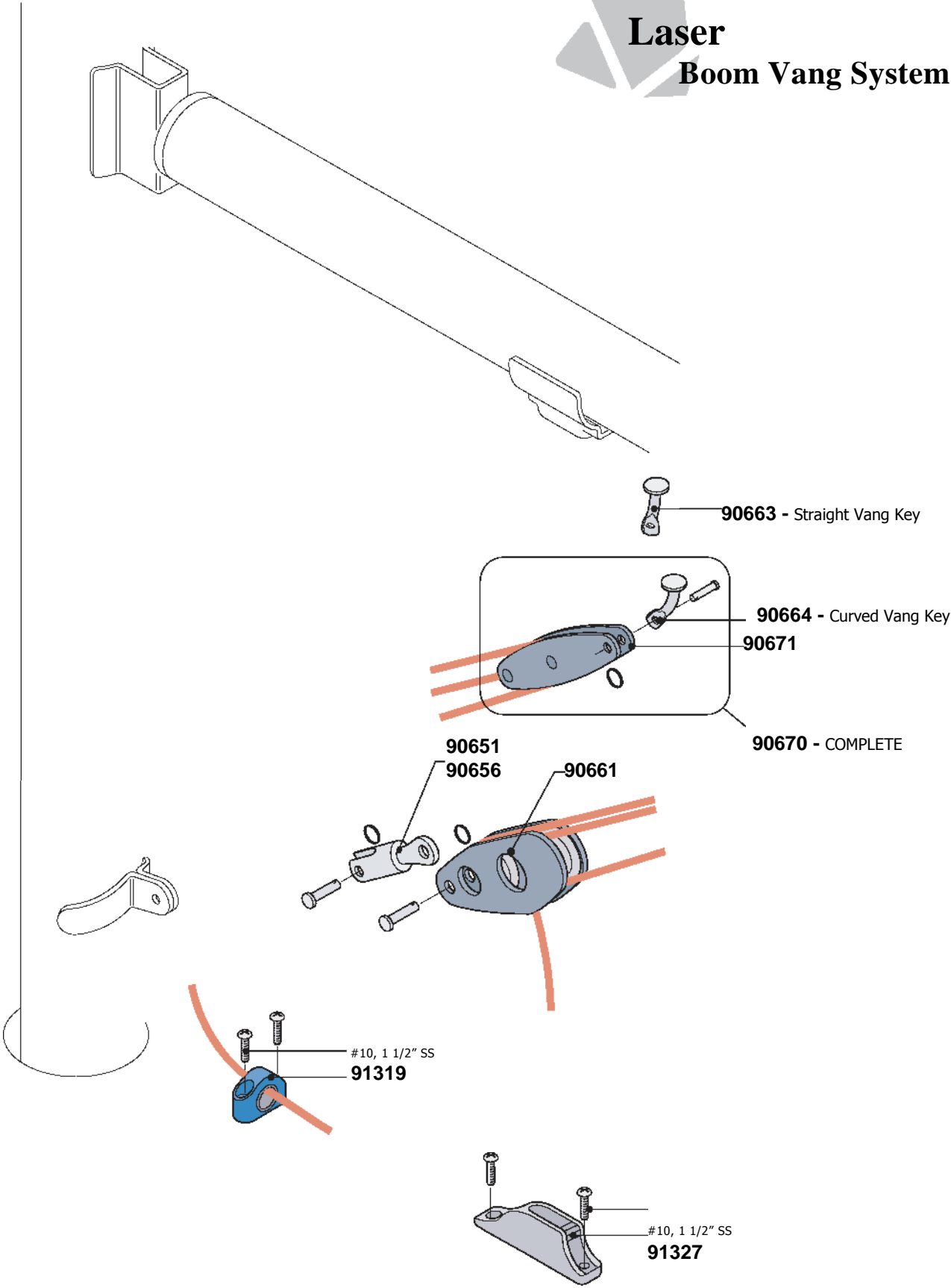

Laser Race Boom Vang System

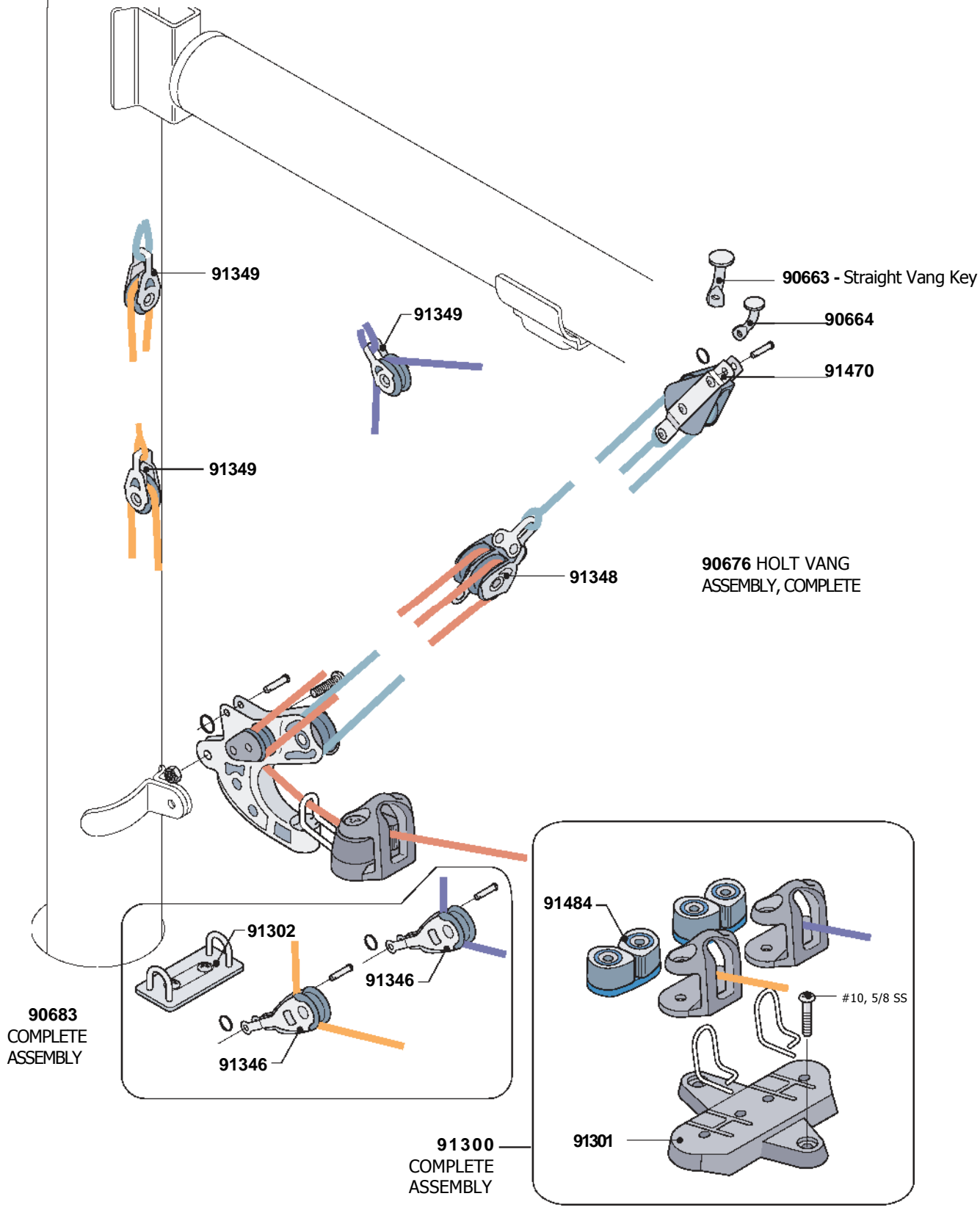

Laser XD Boom Vang System

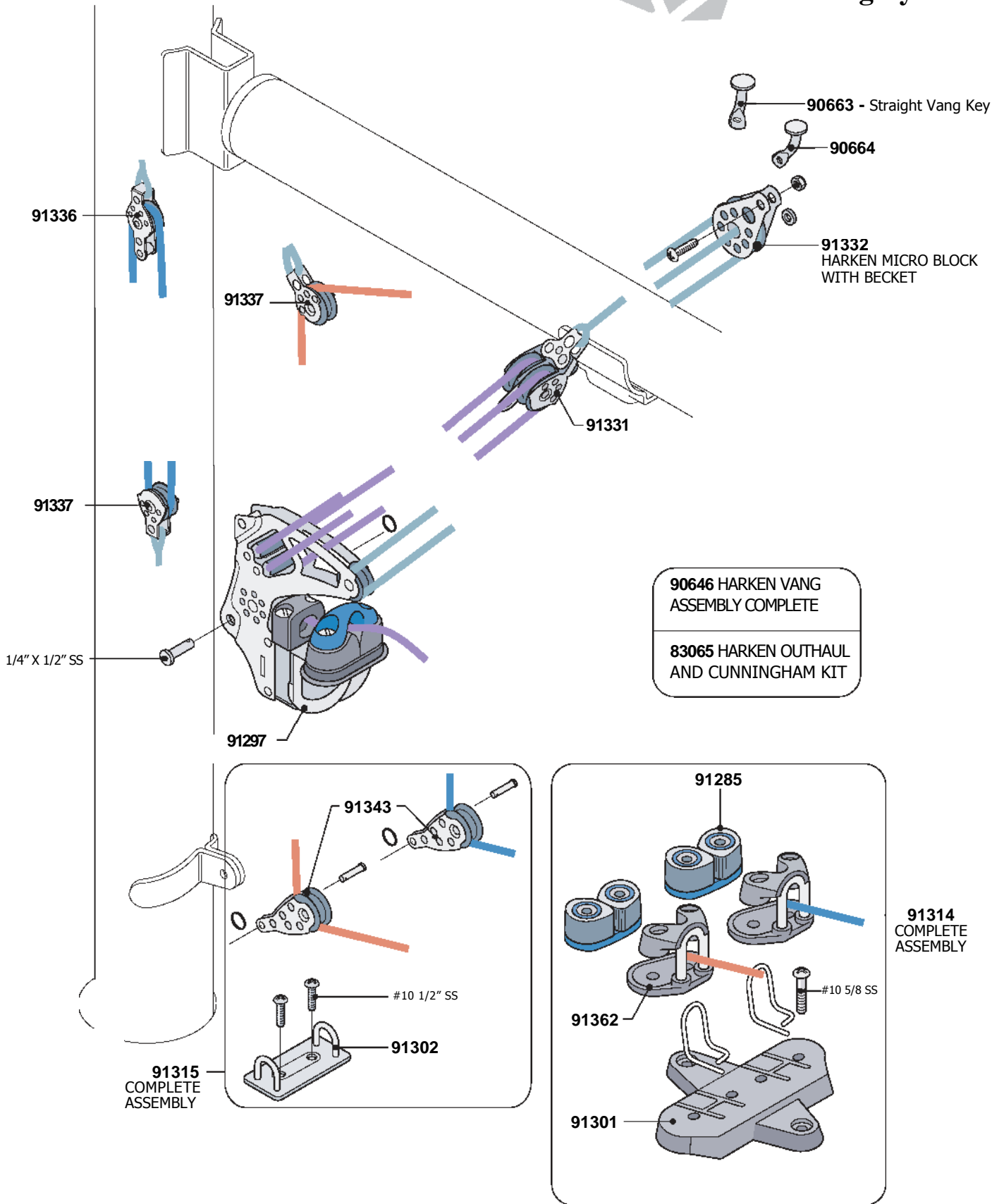

Laser Deck Fittings

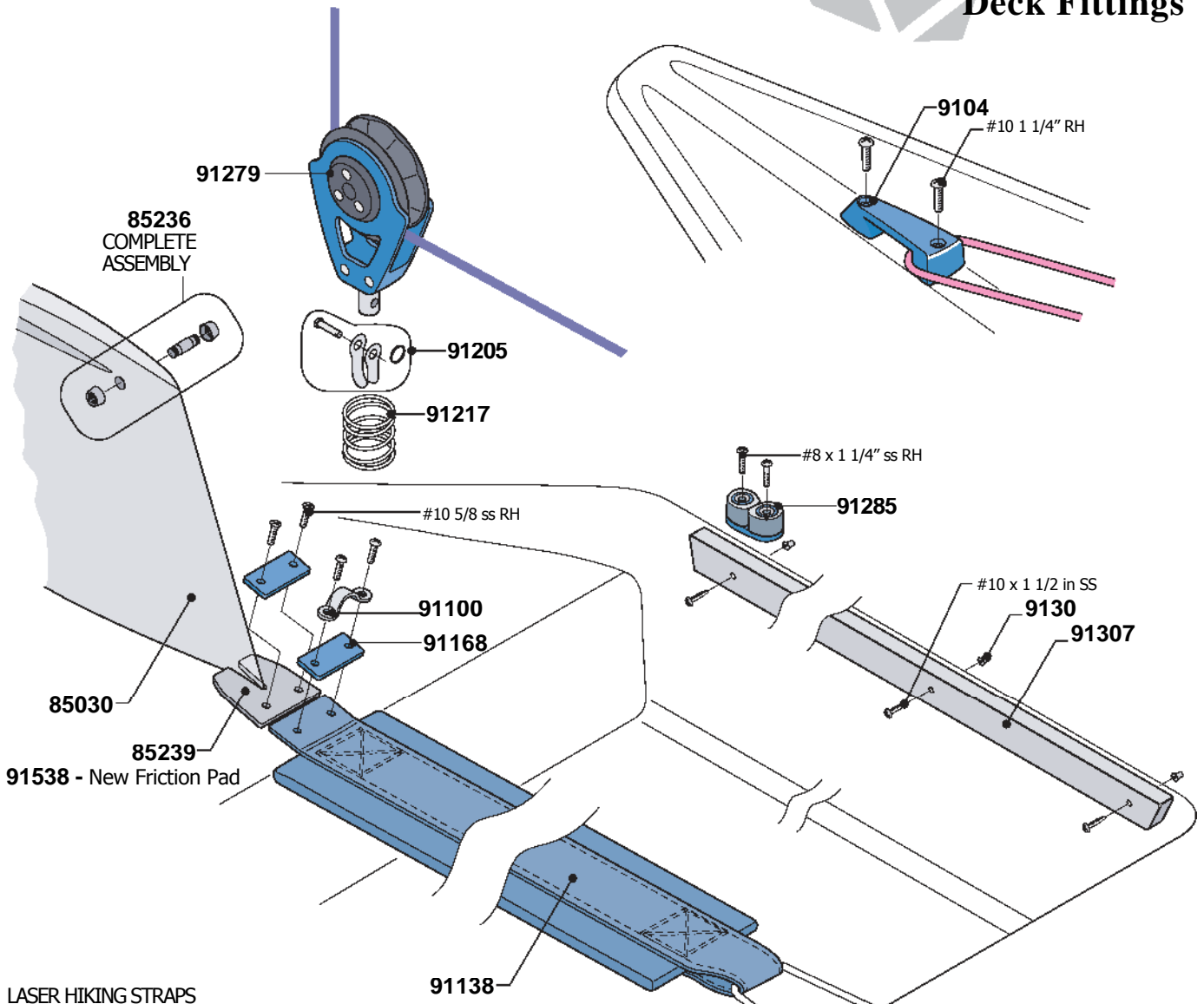

LASER HIKING STRAPS

- 91140 Blue with White Logo
- 91138 New Zealand Style - blue/white
- 91139 Black nylon webbing
- 91141 Grey 5in band
- 91142 Seitech strap
- 91143 White with Blue Logo
- 91293 *New* XD style

91284
COMPLETE
ASSEMBLY

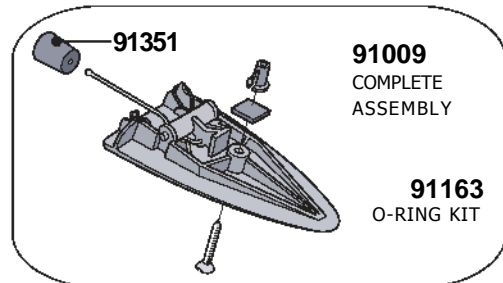
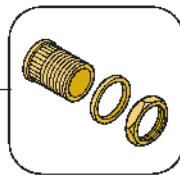

Laser Race Deck Fittings

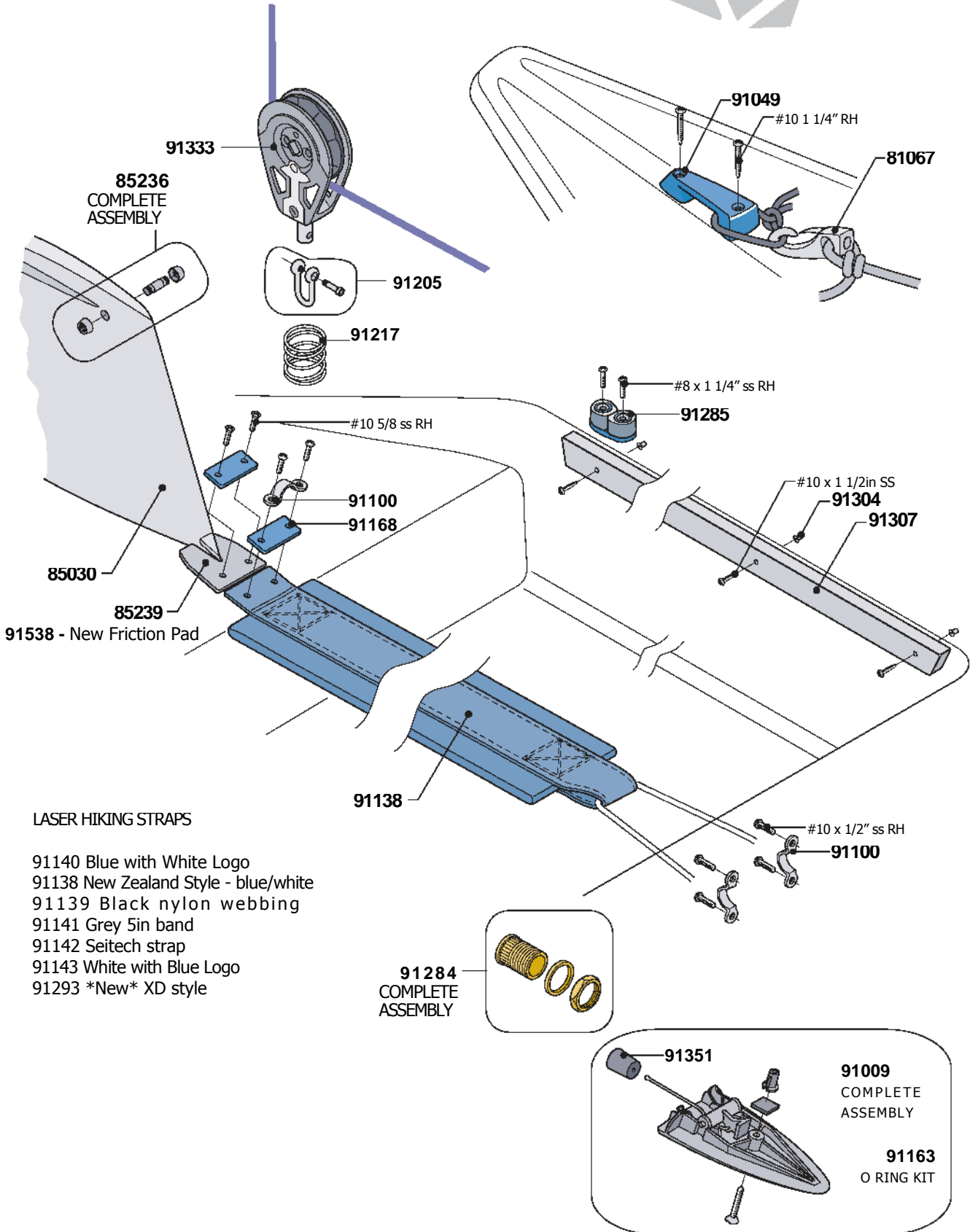

LASER HIKING STRAPS

- 91140 Blue with White Logo
- 91138 New Zealand Style - blue/white
- 91139 Black nylon webbing
- 91141 Grey 5in band
- 91142 Seitech strap
- 91143 White with Blue Logo
- 91293 *New* XD style

Laser XD Deck Fittings

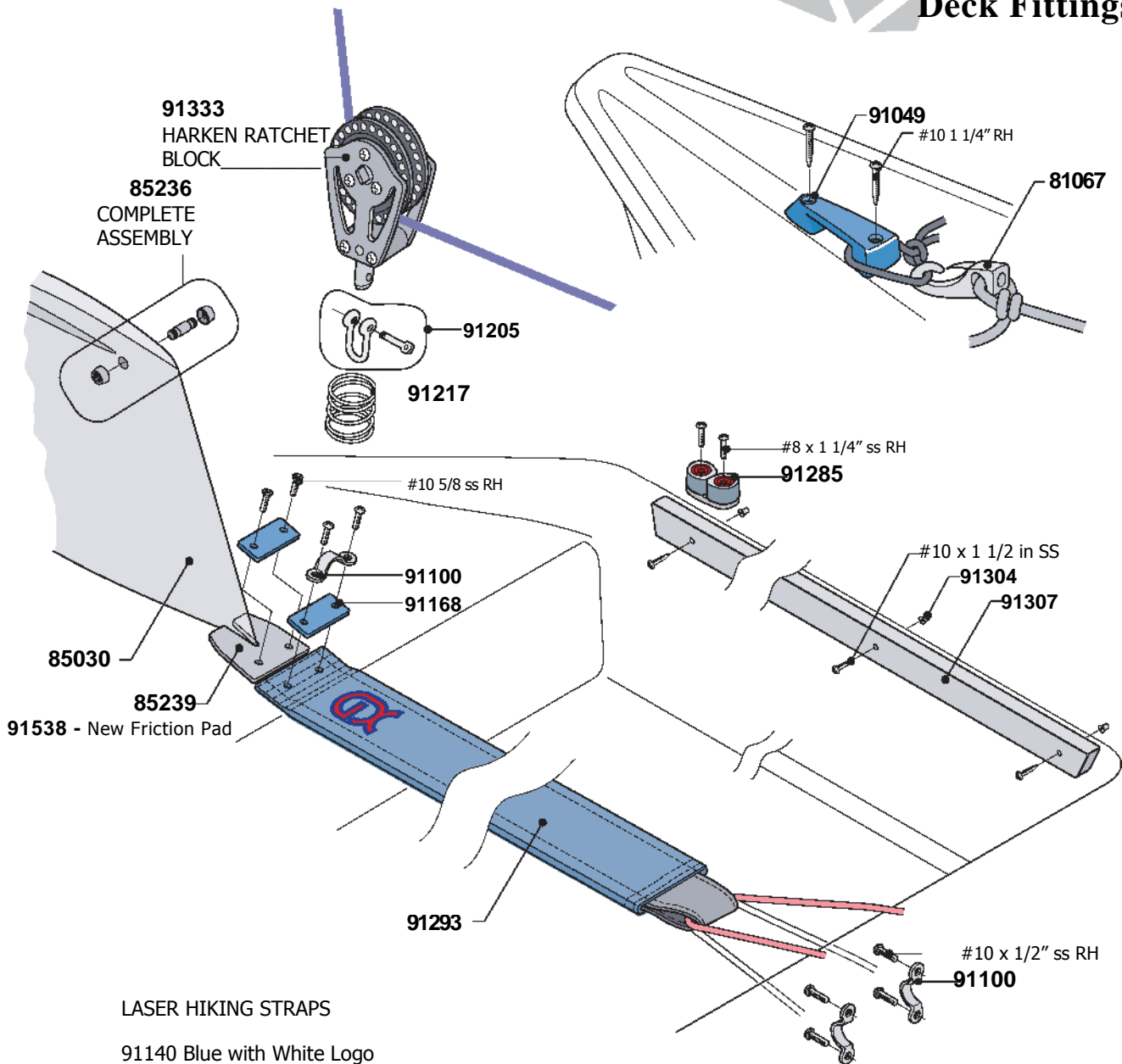

LASER HIKING STRAPS

- 91140 Blue with White Logo
- 91138 New Zealand Style - blue/white
- 91139 Black nylon webbing
- 91141 Grey 5in band
- 91142 Seitech strap
- 91143 White with Blue Logo
- 91293 *New* XD style

91284
COMPLETE
ASSEMBLY

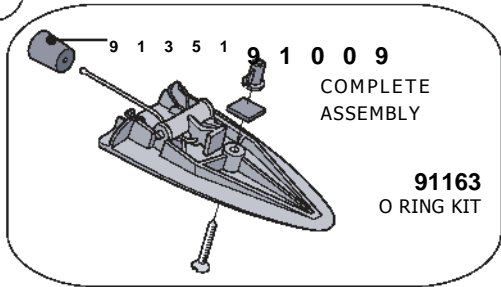
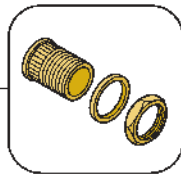

Laser & Laser Race Rudder and Tiller Assembly

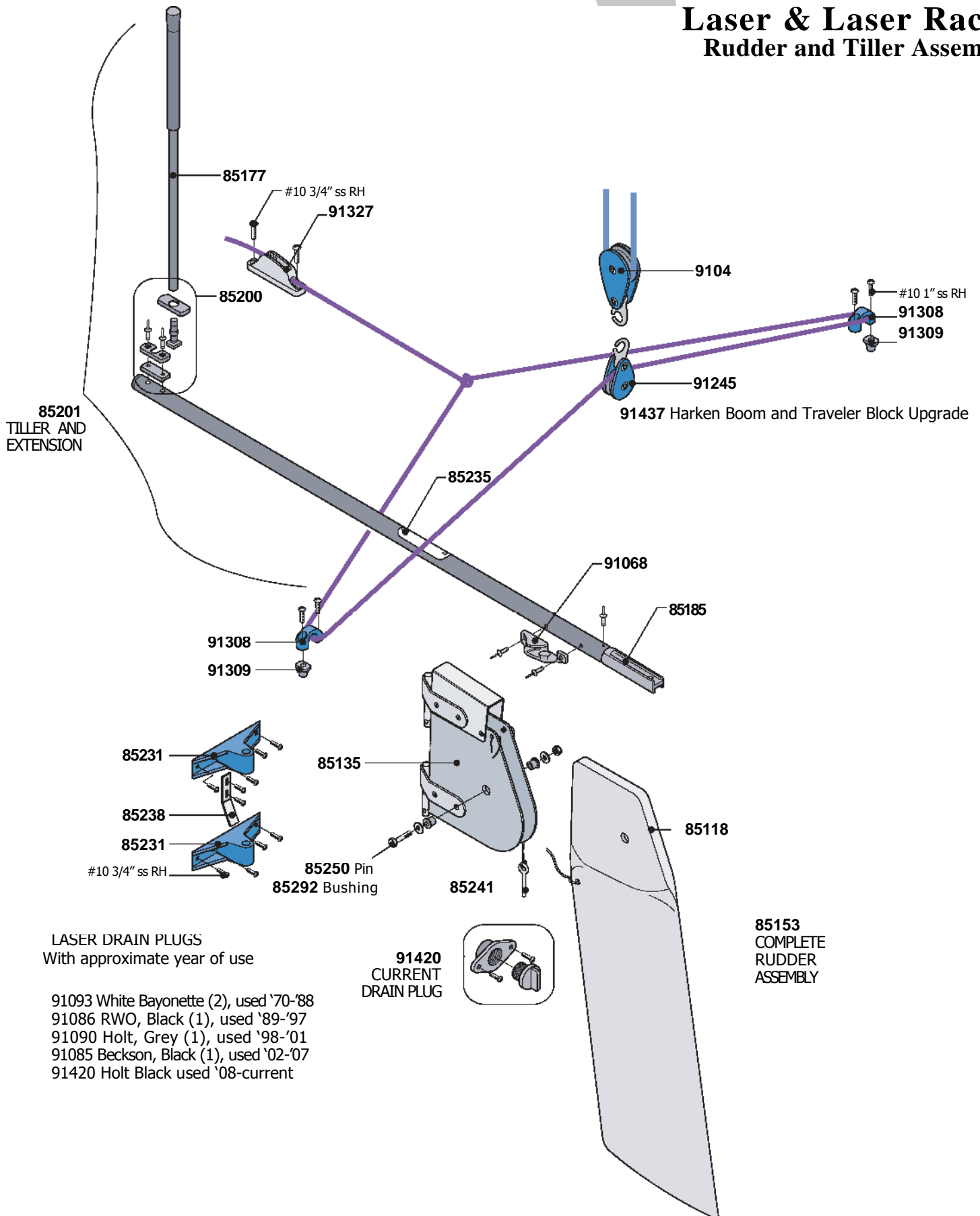

85201
TILLER AND
EXTENSION

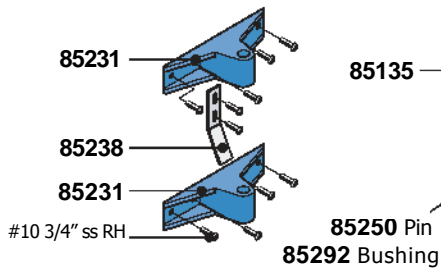

LASER DRAIN PLUGS
With approximate year of use

- 91093 White Bayonette (2), used '70-'88
- 91086 RWO, Black (1), used '89-'97
- 91090 Holt, Grey (1), used '98-'01
- 91085 Beckson, Black (1), used '02-'07
- 91420 Holt Black used '08-current

91420
CURRENT
DRAIN PLUG

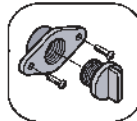

85153
COMPLETE
RUDDER
ASSEMBLY



Laser XD Rudder and Tiller Assembly

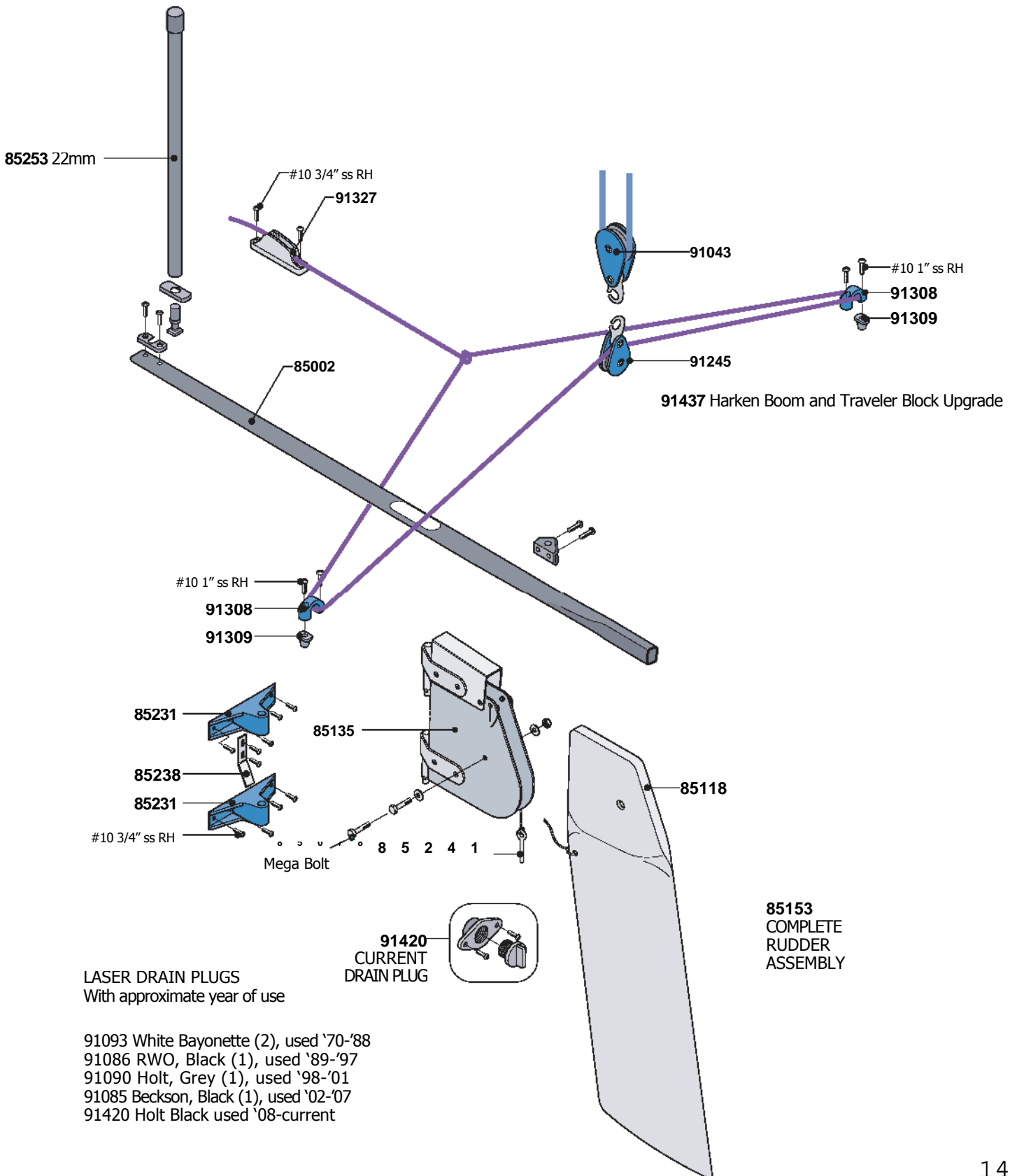



Laser Technical Information

Hull Weight	130 lbs	59 kg
LOA	13.1 ft	4.2 m
Beam	4.6 ft	1.4 m
Draft	2.7 ft	0.8 m
Laser Sail Area	76 sq ft	7.1 sq m
Radial Sail Area	62 sq ft	5.8 sq m
4.7 Sail Area	50 sq ft	4.7 sq m

Laser Classic Line Specifications

Description	Diameter (in)	Diameter (mm)	Type	Length	Quantity
Mainsheet	9/32 in	7mm	Marstrand	43 ft	1
Traveler	3/16 in	5mm	prestretch	11.5 ft	1
Cunningham	3/16 in	5mm	Dyneema	16.5 ft	1
Vang	3/16 in	5mm	prestretch	16.5 ft	1
Outhaul	3/16 in	5mm	Dyneema	23 ft	1
Clew Tie Down	5/32 in	4mm	Dyneema	2 ft	1
DB Retainer	3/16 in	5mm	shockcord	10 ft	1
Mast Retainer	5/32 in	4mm	prestretch	4.5 ft	1

Laser Race Line Specifications

Mainsheet	1/4 in	6mm	Marstrand	43 ft	1
Traveler	3/16 in	5mm	prestretch	11.5 ft	1
DB Retainer	9/32 in	7mm	shockcord	3.5 ft	1
Cunningham Primary	5/32 in	4mm	Dyneema	2 ft	1
Cunningham Secondary	5/32 in	4mm	Dyneema	16 ft	1
Outhaul Bungee	3/16 in	5mm	shockcord	3.5 ft	1
Outhaul Secondary	3/16 in	5mm	Dyneema	13 ft	1
Mast Retainer	5/32 in	4mm	prestretch	3 ft	1
Vang Primary	5/32 in	3.5 mm	Dyneema	4.5 ft	1
Vang Secondary	3/16 in	5mm	Dyneema	15 ft	1

Laser XD Line Specifications

Block to clam cleat tie in	1/8 in	3mm	Vectran	1.5 ft	1
Block to clew tie in	1/8 in	3mm	Vectran	1.5 ft	1
Cunningham Block tie in	1/8 in	3mm	Vectran	2 ft	1
Cunningham Primary	5/32 in	4mm	Vectran	4 ft	1
Cunningham Secondary	5/32 in	4mm	Prestrech	13 ft	1
DB Retainer	9/32 in	7mm	Shockcord	3.5 ft	1
DB Bow tie	1/8 in	3mm	Prestrech	1 ft	1
Mainsheet	1/4 in	6mm	Spectra	46 ft	1
Mast Block tie in	1/4 in	3mm	Vectran	2 ft	1
Mast Retainer	1/4 in	3mm	Prestrech	2 ft	1
Outhaul Bungee	9/32 in	7mm	Shockcord	3.5 ft	1
Outhaul Primary	1/4 in	3mm	Vectran	5 ft	1
Outhaul Secondary	5/32 in	4mm	Prestrech	20 ft	1
Traveler	3/16 in	5mm	Vectran	10 ft	1
Vang Primary	1/8 in	3mm	Vectran	4.5 ft	1
Vang Secondary	5/32 in	4mm	Dyneema	15 ft	1
Vang Tang Bungee	1/8 in	3mm	shockcord	1 ft	1



erLas Parts & Accessories List

Part #	Description	2010 Retail		
Accessories				
83009	FLAG, PROTEST	11.95		
83010	WIND INDICATOR, LASER/OPTI MK2KINGFISHER	28.00		
83014	KIT, MAST STEP REPAIR, LASER	395.00		
83041	WIND INDICATOR,KINGFISHER K100	15.35		
83055	CLEW SLEEVE, LASER, HARKEN	51.00		
83068	BAG, FAT BAG, 5", FOR VIKING DECKPLATE	26.00		
91078	CLEW STRAP, LASER	18.80		
Blades				
81067	DAGGERBOARD RETAINER SHOCKCORD	16.00		
85002	TILLER,CARBON, LASER XD	230.00		
85030	DAGGERBOARD, LASER, COMPLETE	390.50		
85040	FOIL PROTECTOR SET, LASER	34.00		
85078	RUDDER BOLT, MEGA	5.80		
85118	RUDDER BLADE, LASER	165.00		
85135	RUDDER HEAD, LASER	126.00		
85153	RUDDER, LASER, COMPLETE	298.50		
85177	TILLER EXTENSION, GORILLA TILLER	53.00		
85185	END CASTING, GORILLA TILLER, LASER	34.00		
85193	TILLER EXTENSION, 33"	47.00		
85194	TILLER EXTENSION, 36"	48.00		
85195	TILLER EXTENSION, 48"	52.00		
85200	UNIVERSAL, GORILLA TILLER	7.35		
85201	TILLER, GORILLA W/EXTENSION	158.50		
85231	GUDGEON, LASER	8.70		
85235	WEAR PLATE, GORILLA TILLER	6.35		
85236	STOP SET, DAGGERBOARD, BLUE	8.85		
85237	TILLER WEDGE	15.40		
85238	STOP, RUDDER LIFT	7.70		
85241	PIN, RETAINING W/LINE	5.15		
85245	UNIVERSAL, BLACK, OMNIFLEX	8.85		
85246	SADDLE, TILLER EXT, FOR RONSTAN EXT	2.55		
85250	PIN, PIVOT, RUDDER, LASER	4.60		
85251	CLEAT, JAM, FOR LASER TILLER	2.05		
85253	TILLER EXTENSION, CARBON, LASER XD	99.00		
85292	BUSHING ASSEMBLY, RUDDER, BLUE	6.25		
91068	CLEAT, CLAM, GORILLA TILLER	18.00		

Part #	Description	2010 Retail		
Covers				
87104	COVER, DECK, LASER, STORM	241.50		
87105	COVER, HULL, LASER, STORM	246.50		
87106	BLADE BAG, LASER	123.00		
87107	SPAR BAG, LASER	108.00		
Hull, Deck, Spar Hardware and Line				
81034	LINE BAG, DELIVERY, LASER	111.00		
83065	OUTHAUL & CUNNINGHAM UPGRADE KIT, HARKEN	304.50		
85239	CENTERBOARD BRAKE, "w", LASER	3.05		
90646	VANG SYSTEM UPGRADE, LASER, HARKEN	284.50		
90651	VANG SWIVEL, LASER SUPER	69.00		
90656	VANG SWIVEL, LASER	15.70		
90661	BLOCK, VANG, W/JAM, PIN & RING	25.00		
90663	KEY, VANG, STRAIGHT	8.70		
90664	KEY, VANG, CURVED	8.20		
90667	BLOCK, BOOM, BLUE	15.10		
90668	EYESTRAP KIT, PLASTIC LACING EYE	7.70		
90670	BLOCK, VANG, W/KEY	21.00		
90671	BLOCK, VANG, LASER, W/O KEY	16.70		
90673	BECKET BLOCK KIT - BLUE	22.00		
90674	BLOCK KIT, BULLET, BLUE	19.95		
90676	VANG SYSTEM, LASER, HOLT	183.50		
90683	PLATE, BLOCK, W/HOLT BLOCKS	58.00		
91004	CUBITAINER, 20 LITRE	10.80		
91005	CUBITAINER, 10 LITRE	9.15		
91009	AUTOBAILER, LASER	87.00		
91020	EYESTRAP KIT, STAINLESS LACING	8.05		
91043	BLOCK, TRAVELER, LARGE, BLUE	22.00		
91049	BOW EYE, BLUE	12.80		
91100	EYESTRAP, REGULAR, 2-HOLE	2.55		
91102	FAIRLEAD, ALMAG, 26MM HOLESPPACING, BLACK ANODIZE	14.65		
91149	HOOK, BRUMMEL (2)	12.30		
91163	O RING KIT, BAILER, LASER, (4)	10.10		
91168	PLATE, HIKING STRAP, PLASTIC	7.15		
91172	PLUG, DRAIN COCKPIT	2.00		
91205	SHACKLE, W/PIN&RING, 3/16"	3.60		
91217	SPRING, STANDUP, LARGE	2.05		
91245	BLOCK, TRAVELER, SMALL, BLUE	15.00		

Part #	Description	2010 Retail		
91279	BLOCK, RATCHET, NAUTEC, RED	54.00		
91284	BUSHING ASSEMBLY, COCKPIT	25.00		
91285	CLEAT, CAM, MICRO, HARKEN	23.00		
91297	BASE UNIT, HARKEN VANG UPGRADE	238.50		
91300	PLATE, CLEAT, W/HOLT CLEATS, CUNNINGHAM AND OUTH	102.00		
91301	PLATE, CLEAT, FOR LASER CUNNINGHAM & OUTHAUL (no	46.00		
91302	PLATE, BLOCK, FOR LASER CUNNINGHAM & OUHAUL	39.00		
91304	NUT, CAPTIVE (10)	12.80		
91307	GRABRAIL, GREY	21.00		
91308	FAIRLEAD, BLUE	3.35		
91309	CAP, LARGE, SELF-TAPPING (2)	7.45		
91311	BLOCK, MICRO, DOUBLE W/BECKET	33.00		
91314	PLATE, CLEAT, W/HARKEN CLEATS	101.00		
91315	PLATE, BLOCK, W/HARKEN BLOCKS	59.00		
91319	FAIRLEAD, W/SS INSERT, BLUE	15.10		
91320	FAIRLEAD, FOR MINI CAM CLEAT, HARKEN	14.05		
91321	FAIRLEAD, ALMAG, 23MM HOLE SPACING, BLACK ANODI	10.25		
91324	EYESTRAP	5.65		
91327	CLEAT, CLAM, ALUMINUM	14.35		
91331	BLOCK,DOUBLE BECKET,VANG, LASER,HARKEN	24.50		
91332	BLOCK,BECKET,VANG,LASER,W/RING AND PIN, HARKEN	39.00		
91333	BLOCK, RATCHET, HARKEN 2.25"	56.00		
91336	BLOCK, MICRO, SINGLE W/BECKET	11.80		
91337	BLOCK, MICRO, SINGLE	10.25		
91343	BLOCK, 16MM, FORK MOUNT	26.00		
91346	BLOCK, W/FORK, HOLT, 20mm	15.10		
91347	BLOCK, W/HOOK, HOLT, 20mm	15.10		
91348	BLOCK, DOUBLE W/BECKET, HOLT, 20mm	28.00		
91349	BLOCK, SINGLE, HOLT, 20mm	11.65		
91351	BUNG, COCKPIT, LASER	11.90		
91362	FAIRLEAD, XTRM MINI CAM CLEAT	16.00		
91437	HARKEN BOOM AND TRAVELLER BLOCK UPGRADE KIT	98.00		
91470	BLOCK, W/BECKET AND FORK, HOLT	28.00		
91484	CLEAT, SMALL, ALANITE	22.00		
91538	CENTERBOARD BRAKE , MK 2 *NEW*	17.00		
Laser Drain Plugs				
91085	DRAIN BUNG, BECKSON	USED 2002-2007	4.60	
91086	DRAIN PLUG ASSY, BLACK, RWO	USED 1989-1997	4.60	
91087	DRAIN PLUG ASSY, COCKPIT		7.40	
91090	DRAIN PLUG, GREY, (1)	USED 1998-2001	8.20	
91420	DRAIN PLUG, HOLT, BLACK	USED 2008-	3.85	
	CLIPPE			

Part #	Description	2010 Retail
Laser Hiking Straps		
91138	HIKING STRAP, LASER NZ	42.00
91139	HIKING STRAP, LASER, BLACK WEB, 34", LOOP ON EACH E	14.05
91140	HIKING STRAP, LASER, BLUE W / WHITE	32.00
91141	HIKING STRAP, LASER, GREY, 5" WIDE	48.00
91142	HIKING STRAP, LASER, SEITECH	44.00
91143	HIKING STRAP, LASER, WHITE	32.00
91293	HIKING STRAP, XD	46.00
Harken Vang Upgrade Hardware		
83065	OUTHAUL & CUNNINGHAM UPGRADE KIT, HARKEN	304.50
90646	VANG SYSTEM UPGRADE, LASER, HARKEN	284.50
90664	KEY, VANG, CURVED	8.20
91285	CLEAT, CAM, MICRO, HARKEN	23.00
91297	BASE UNIT, HARKEN VANG UPGRADE	238.50
91301	PLATE, CLEAT, FOR LASER CUNNINGHAM & OUTHAUL (no	46.00
91302	PLATE, BLOCK, FOR LASER CUNNINGHAM & OUHAUL (no	39.00
91311	BLOCK, MICRO, DOUBLE W/BECKET	33.00
91314	PLATE, CLEAT, W/HARKEN CLEATS	101.00
91315	PLATE, BLOCK, W/HARKEN BLOCKS	59.00
91320	FAIRLEAD, FOR MINI CAM CLEAT, HARKEN	14.05
91331	BLOCK, DOUBLE BECKET, VANG, LASER, HARKEN	24.50
91332	BLOCK,BECKET, VANG, LASER, W/RING & PIN HARKEN	39.00
91336	BLOCK, MICRO, SINGLE W/BECKET	11.80
91337	BLOCK, MICRO, SINGLE	10.25
91343	BLOCK, 16MM, FORK MOUNT	26.00
Sails		
94100	SAIL, LASER, NORTH, FOLDED	563.50
94101	SAIL, LASER RADIAL, HYDE, FOLDED	657.00
94102	SAIL, LASER 4.7, HYDE, FOLDED	524.50
94103	SAIL, LASER, NORTH, ROLLED	650.50
94104	SAIL, LASER RADIAL, NORTH, ROLLED	598.00
94105	SAIL, LASER 4.7, NORTH, ROLLED	498.00
94107	SAIL, LASER, HYDE, FOLDED	664.50
94108	SAIL, LASER RADIAL, NORTH, FOLDED	511.50
94109	SAIL, LASER 4.7, NORTH, FOLDED	455.00
95801	BAG, SAIL, LASER 4.7, WHITE	26.00
95802	BAG, SAIL, LASER RADIAL, RED	26.00
95803	BAG, SAIL, LASER, BLUE	25.00

Part #	Description	2010 Retail		
95842	SAIL NUMBER, BLUE, 9" USA (2 OF EACH LETTER)	22.00		
95843	SAIL NUMBER, BLUE, 9", INDIVIDUAL NUMBERS	3.70		
95844	SAIL NUMBER, RED, 9", INDIVIDUAL NUMBERS	3.55		
95845	NUMBER, SAIL, BLUE, 12", INDIVIDUAL NUMBERS	3.75		
95846	NUMBER, SAIL, RED, 12", INDIVIDUAL NUMBERS	3.75		
95853	NUMBER, SAIL, BLACK, 12", INDIVIDUAL NUMBERS	3.75		
95866	BATTEN SET, LASER	32.00		
95867	BATTEN, LASER, LONG W/ TIPS	13.05		
95868	BATTEN, LASER, SHORT W/ TIPS	9.05		
95869	BATTEN TIP, PACKAGE OF 6	8.20		
Spars				
89034	MAST, LASER, UPPER	207.00		
89035	MAST, LASER, LOWER	304.50		
89036	MAST, LASER RADIAL, LOWER	271.00		
89037	MAST, LASER 4.7, LOWER	304.50		
89407	BOOM, LASER, COMPLETE	313.00		
90418	BOOM SLEEVE ASSEMBLY, LASER	32.00		
90641	BASE PLUG KIT, LOWER MAST, RADIAL/ZUMA	18.30		
90644	VANG TANG KIT, LASER	25.00		
90645	VANG STRAP KIT	14.25		
90647	CONNECTOR SLEEVE KIT, BLUE	9.35		
90650	GOOSENECK PLUG KIT, BLUE	10.05		
90653	VANG, LASER, COMPLETE	76.00		
90654	GOOSENECK KIT, LASER	51.00		
90655	END PLUG, BLUE	6.40		
90660	END PLUG KIT, BLUE	9.60		
90666	GOOSENECK PLUG, LASER, BLUE	7.70		
90672	BASE PLUG KIT, BLUE	8.80		
90675	CONNECTOR PLUG KIT, BLUE	9.25		
91003	PLATE, MAST TUBE 2 1/2" OD	9.85		